

Data sheet | Item number: 286-516

Relay module; Nominal input voltage: 230 VAC; 2 changeover contacts;

Limiting continuous current: 7 A; Red status indicator; Module width: 15 mm



286-516

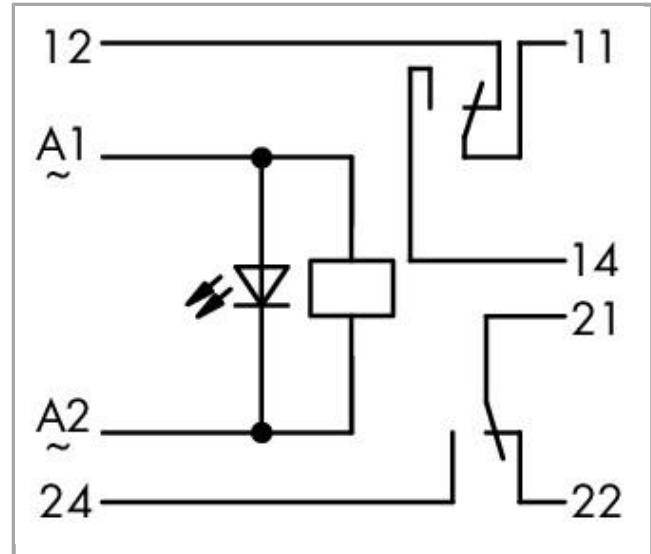

RoHS Compliant

[BOMcheck.net](https://www.bomcheck.net)

Color:

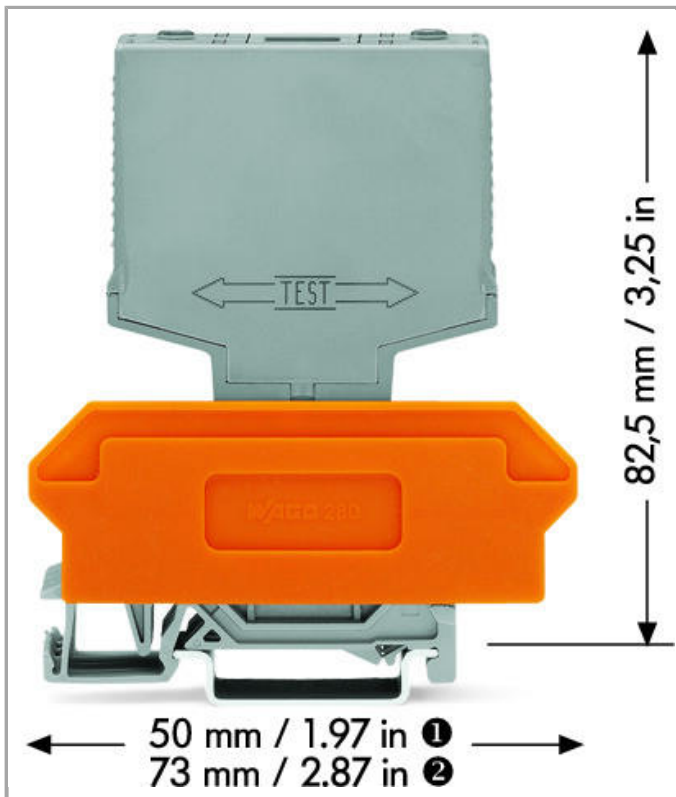

Data

Technical Data

Control circuit

Nominal input voltage U_N	AC 230 V
Input voltage range	$\pm 10\%$
Nominal input current at U_N	5.5 mA

Load circuit:

Number of changeover/switchover contacts	2
Contact material (relay)	AgNi 0.15
Limiting continuous current	7 A
Max. switching voltage	AC 250 V
Max. switching power (resistive)	AC 1,750 VA
Min. switching current	0 μ A
Pull-in time (typ.)	15 ms
Drop-out time (typ.)	3 ms
Bounce time (typ)	2 ms
Drop-out time	$\leq 0 \mu$ s
Electrical life (N.O.; resistive load; 23 °C)	100 x 10 ³ switching operations

Mechanical life (N.O.; resistive load; 23 °C)

30 x 10⁶ switching operations

Signaling

Status indication LED red

Safety and protection:

Rated voltage 250 V

Rated impulse voltage 4 kV

Pollution degree 2

Dielectric strength, control/load circuit (AC, 1 min) 2 kVrms

Dielectric strength open contact (AC, 1 min) 1 kVrms

Dielectric strength, load/load circuit (AC, 1 min) 1.5 kVrms

Protection class IP20

Geometrical Data

Width 20 mm / 0.787 inch

Height from upper-edge of DIN-35 rail 82.5 mm / 3.248 inch

Depth 52 mm / 1.654 inch

Mechanical data

Type of mounting Pluggable module for carrier terminal blocks

Material Data

Color gray

Fire load 0MJ

Weight 35.2 g

Environmental Requirements

Pollution degree 2

Surrounding air (operating) temperature at U_N -25 ... 40 °C

Surrounding air (storage) temperature -25 ... 70 °C

Standards and specifications

Standards/specifications EN 60664-1

Commercial data



Product Group 6 (Interface Electronics)

Country of origin DE









GTIN	4017332291507
Customs Tariff No.	85364900990

Compatible products

General accessories

	Item no.: 280-628 Terminal block for pluggable modules; 16-pole; with 4-conductor terminal blocks; with orange separator; for DIN-rail 35 x 15 and 35 x 7.5; 2.5 mm ² ; CAGE CLAMP®	280-628
	Item no.: 280-638 Terminal block for pluggable modules; 8-pole; with 2-conductor terminal blocks; with orange separator; for DIN-rail 35 x 15 and 35 x 7.5; 2.5 mm ² ; CAGE CLAMP®	280-638
	Item no.: 280-764 Terminal block for pluggable modules; 16-pole; with 4-conductor terminal blocks; with marker carrier; with orange separator; for DIN-rail 35 x 15 and 35 x 7.5; 2.5 mm ² ; CAGE CLAMP®	280-764

Marking accessories

	Item no.: 209-701 WSB marking card; as card; not stretchable; plain; snap-on type	209-701
	Item no.: 209-701/000-002 WSB marking card; as card; not stretchable; plain; snap-on type	209-701 /000-002
	Item no.: 209-701/000-005 WSB marking card; as card; not stretchable; plain; snap-on type	209-701 /000-005
	Item no.: 209-701/000-006 WSB marking card; as card; not stretchable; plain; snap-on type	209-701 /000-006
	Item no.: 209-701/000-007 WSB marking card; as card; not stretchable; plain; snap-on type	209-701 /000-007
	Item no.: 209-701/000-012 WSB marking card; as card; not stretchable; plain; snap-on type	209-701 /000-012
	Item no.: 209-701/000-017 WSB marking card; as card; not stretchable; plain; snap-on type	209-701 /000-017
	Item no.: 209-701/000-023 WSB marking card; as card; not stretchable; plain; snap-on type	209-701 /000-023
	Item no.: 209-701/000-024 WSB marking card; as card; not stretchable; plain; snap-on type	209-701 /000-024



Downloads

Documentation

Bid Text

286-516 Relaisbaustein	Jan 22, 2016	doc 27.1 kB	Download
---------------------------	--------------	----------------	----------

Additional Information

Disposal; Electrical and electronic equipment, Packaging	V 1.0.0	pdf 265.8 kB	Download
--	---------	-----------------	----------

CAD/CAE - Smart Data

CAD data

3D Download 286-516		URL	Download
---------------------	--	-----	----------

Subject to changes.
